

Binding  
Bitterness:  
A guide for  
Constructing  
Witchy  
Tools

# Binding the Book

What you need:

- Embroidery Thread
- A needle
- Material for a cover something sturdy  
(Can use tape to connect the folios instead of handbinding)

# Folding Guide

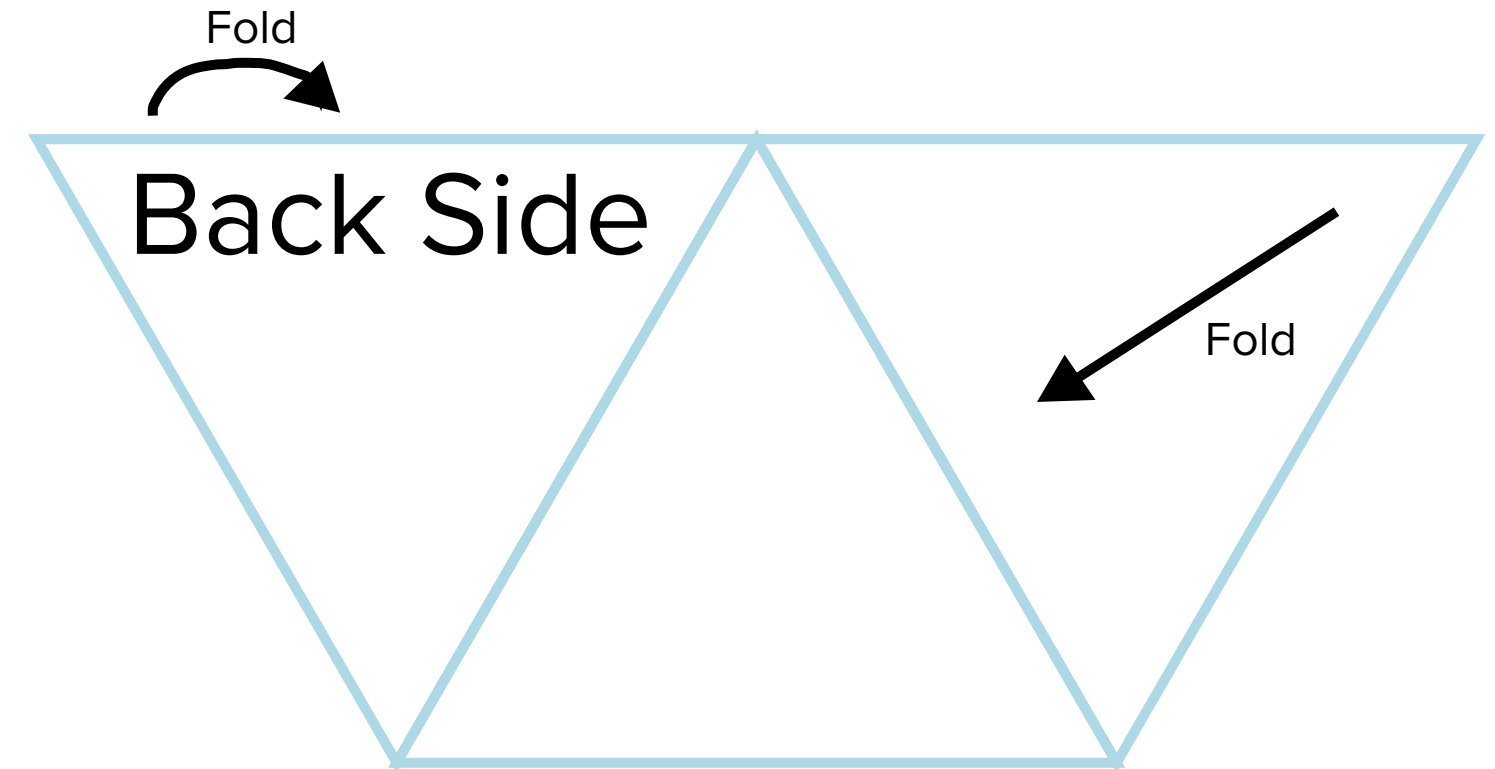

Or

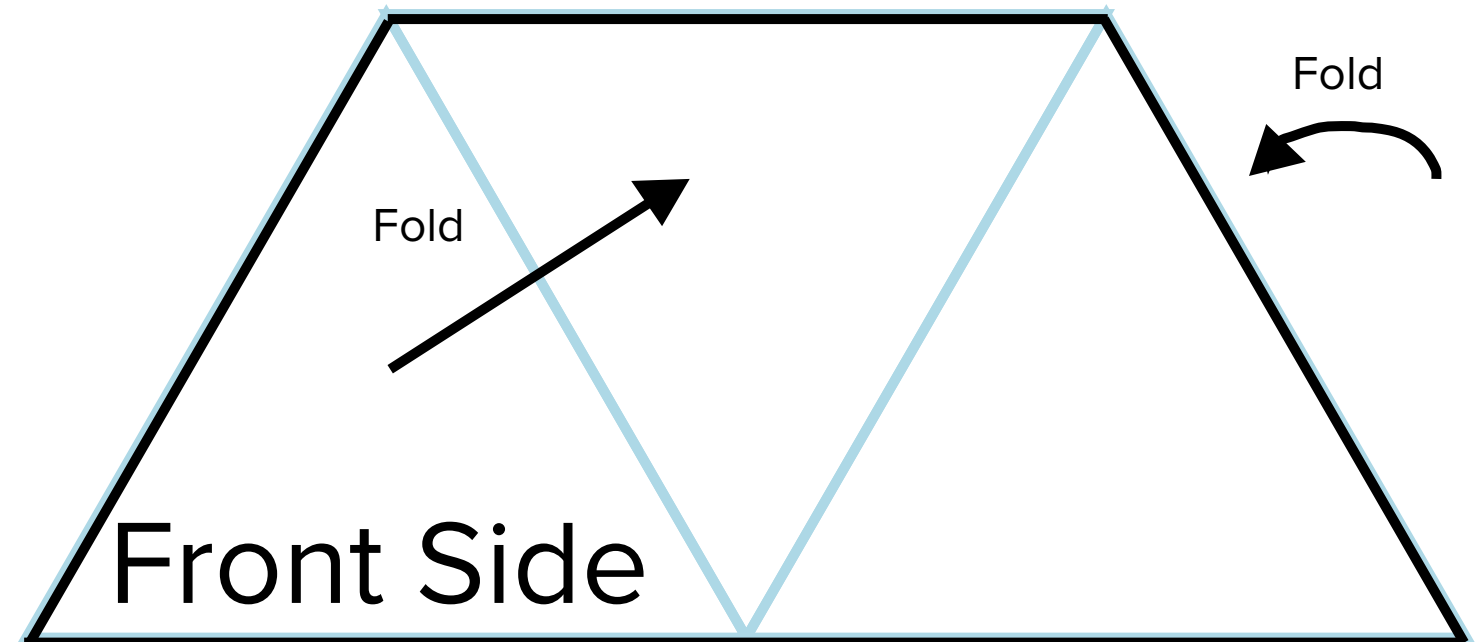

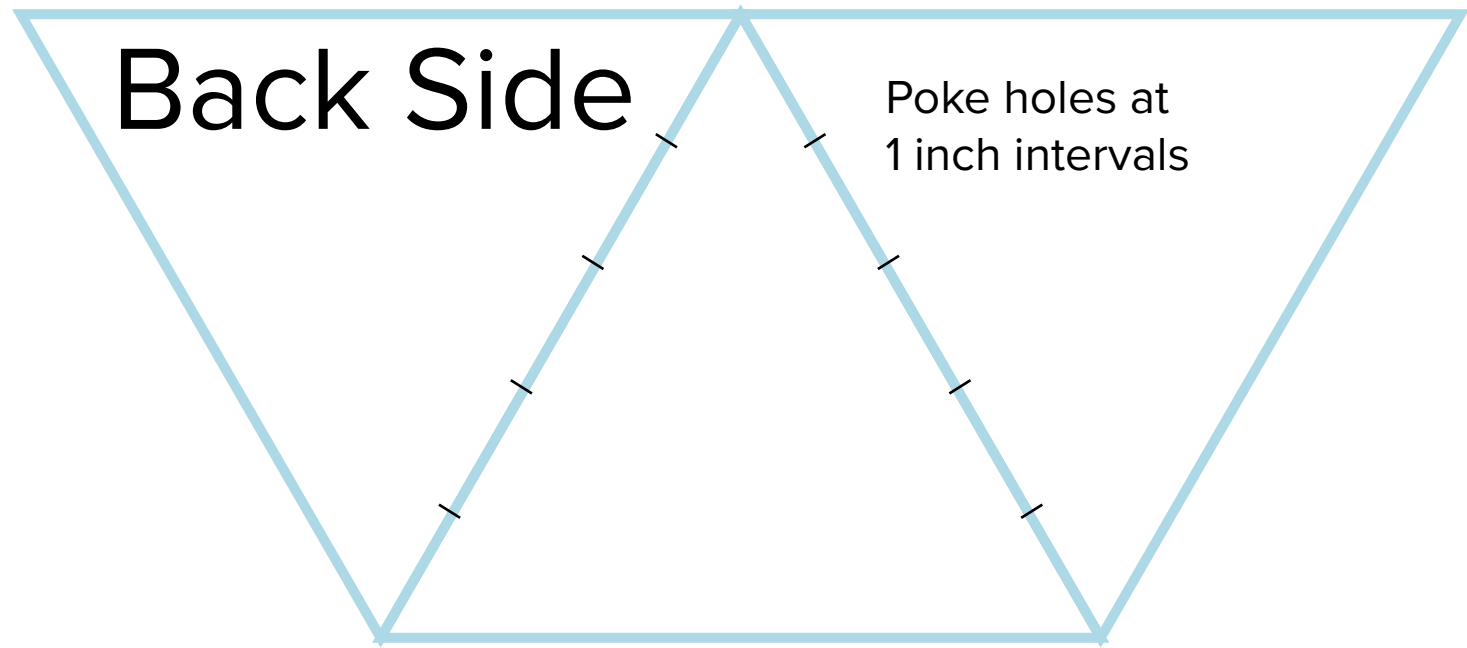

Or

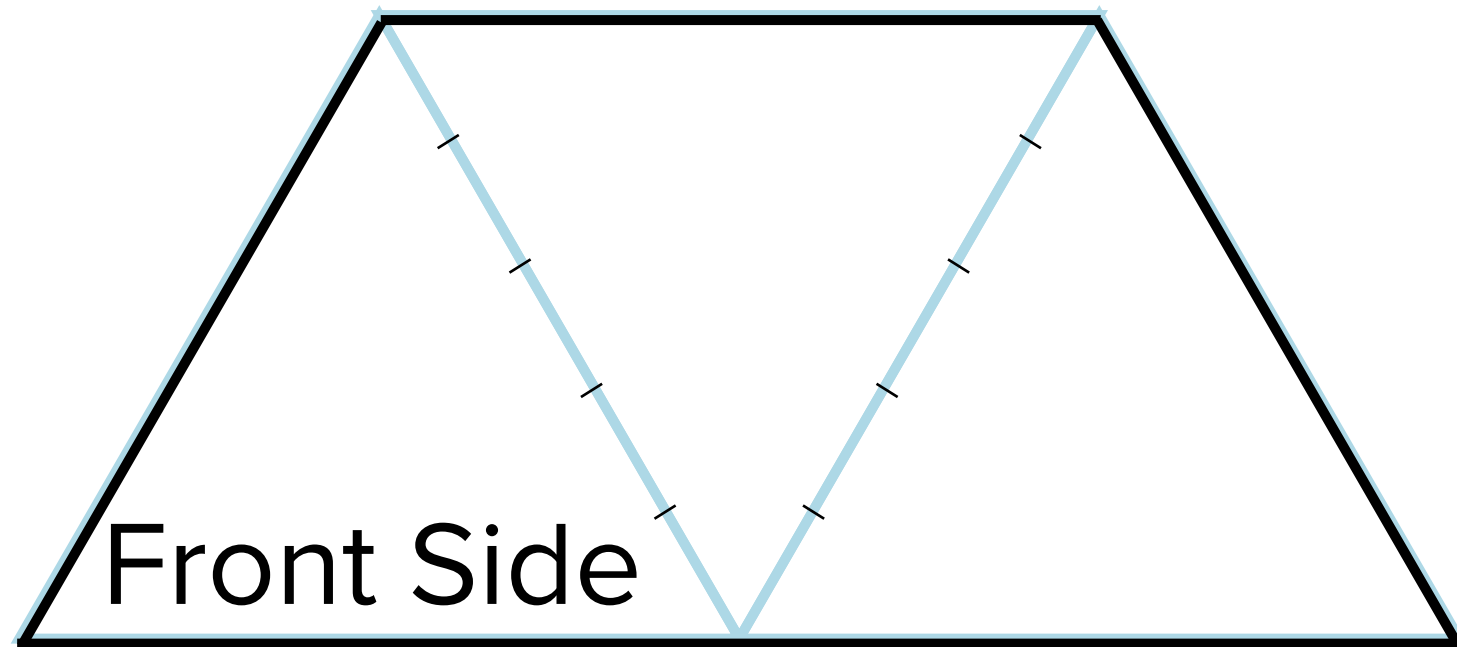

# Step 1

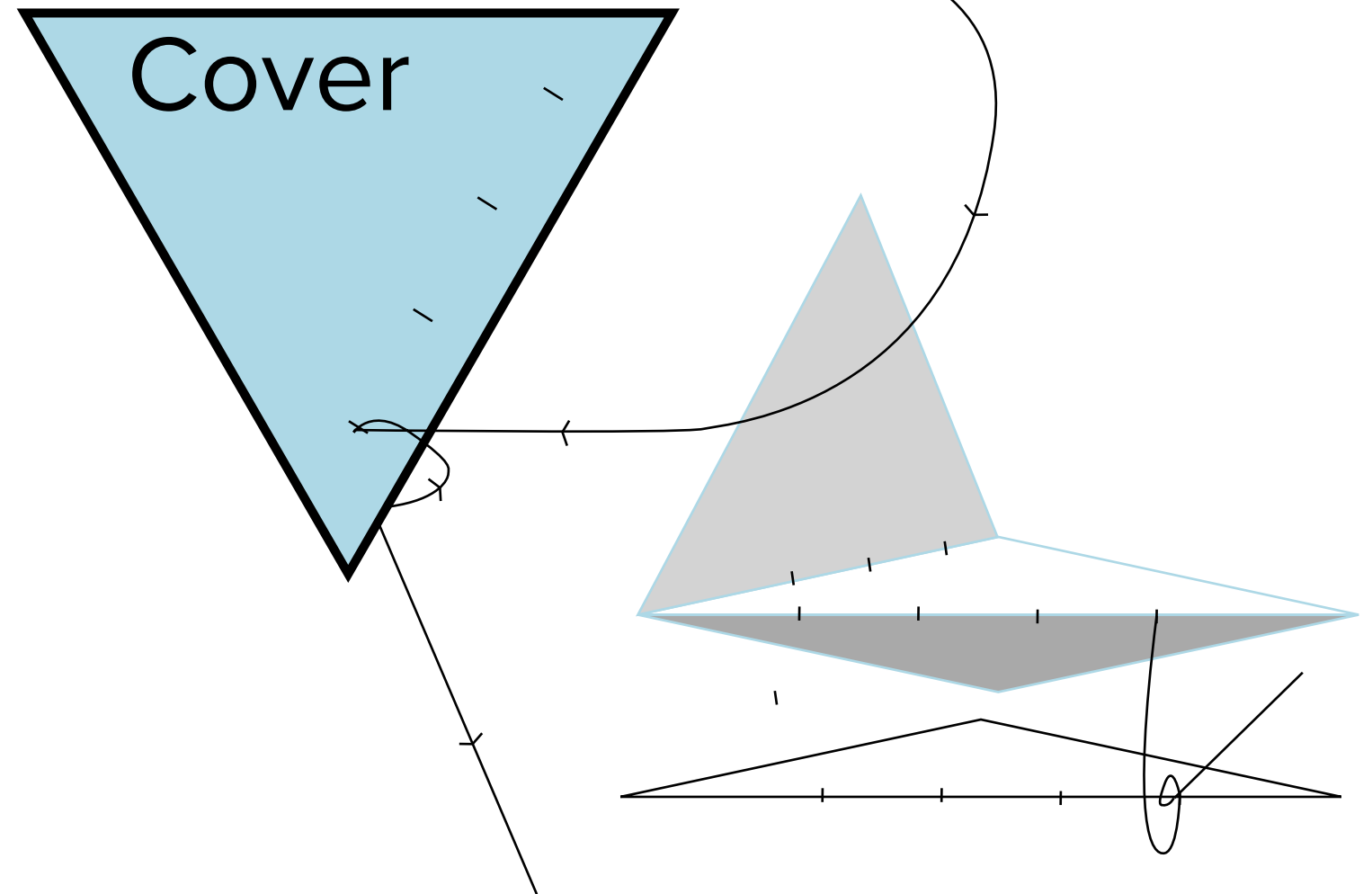
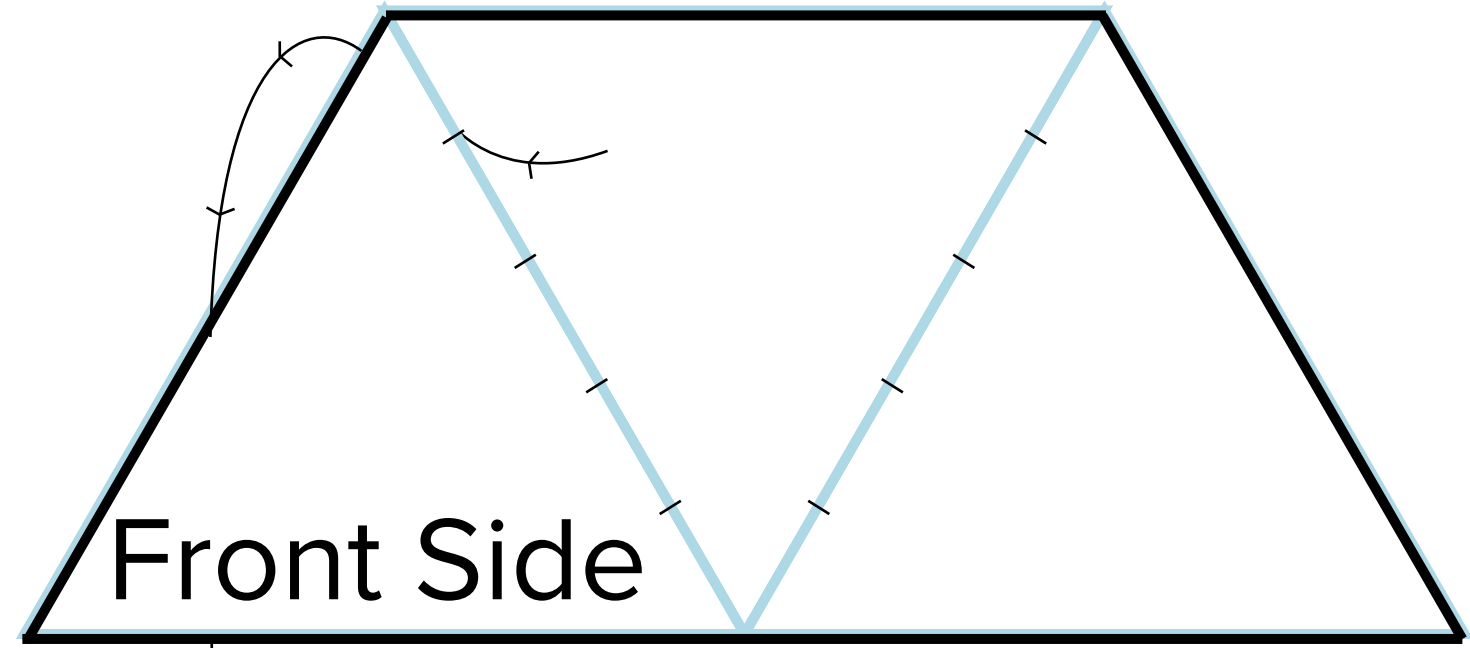

# Step 2

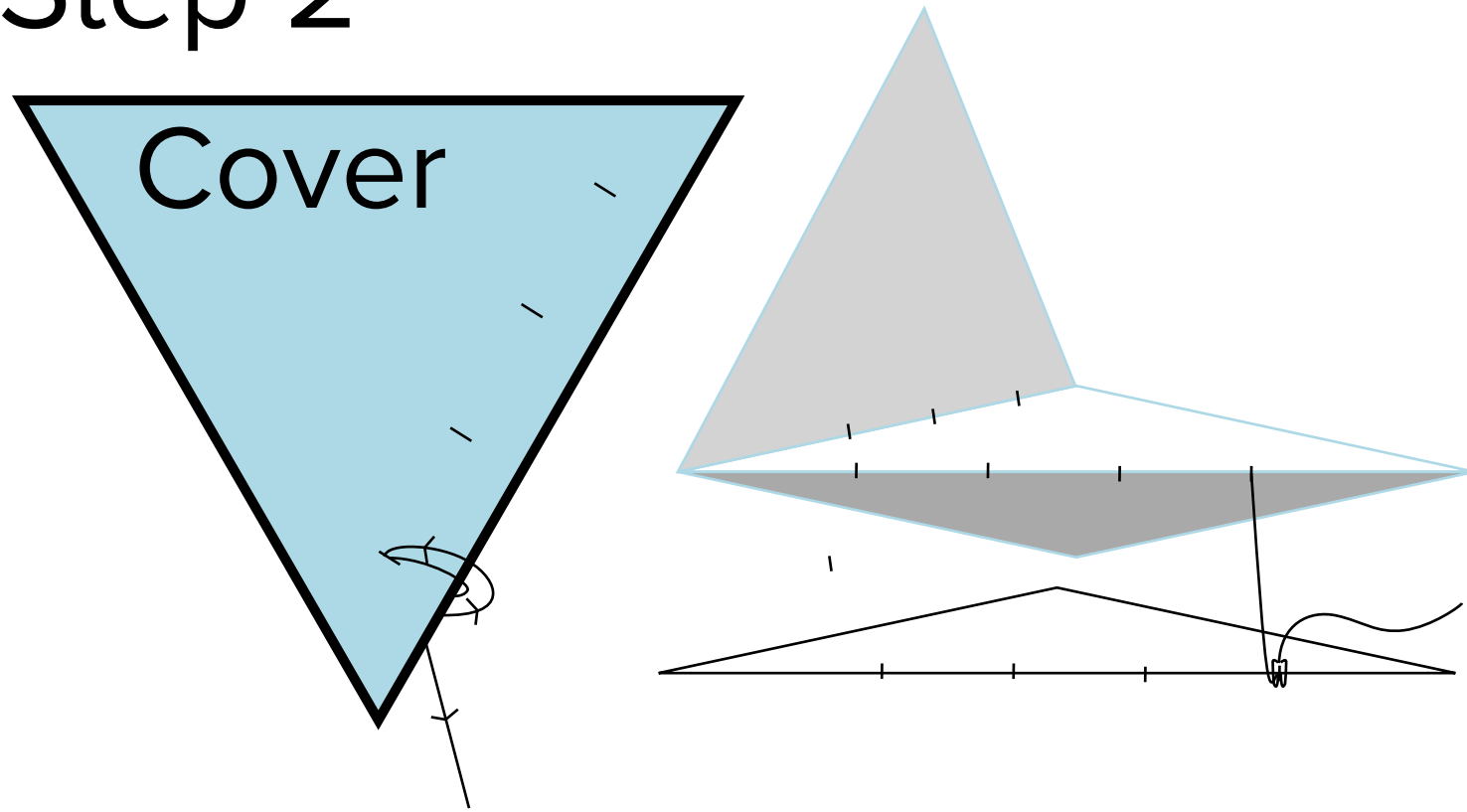

Step 1: With the Front side facing you, take needle and thread and pass it through the top left most hole. Make sure to tie a knot at the end of the thread to keep it from being completely pulled through. Flip over first folio so the back side is facing you. Face the cover towards yourself so that the point of the triangle is directed at yourself and the the holes are on the right side of the triangle. Pass the needle and thread throught the top of the cover through the hole closest to you. Pass it through one more time so it creates a loop around the cover back into the top of the hole.

Step 2: Create a second loop by taking the needle and thread and passing through the top of the bottom most hole on the cover.

Step 3: Wrap the thread around the original thread that is connecting the first folio to the cover. Pass needle underneath the two loops you made on the cover around the first hole. Take needle and thread and enter the same hole we intially went through.

# Step 3

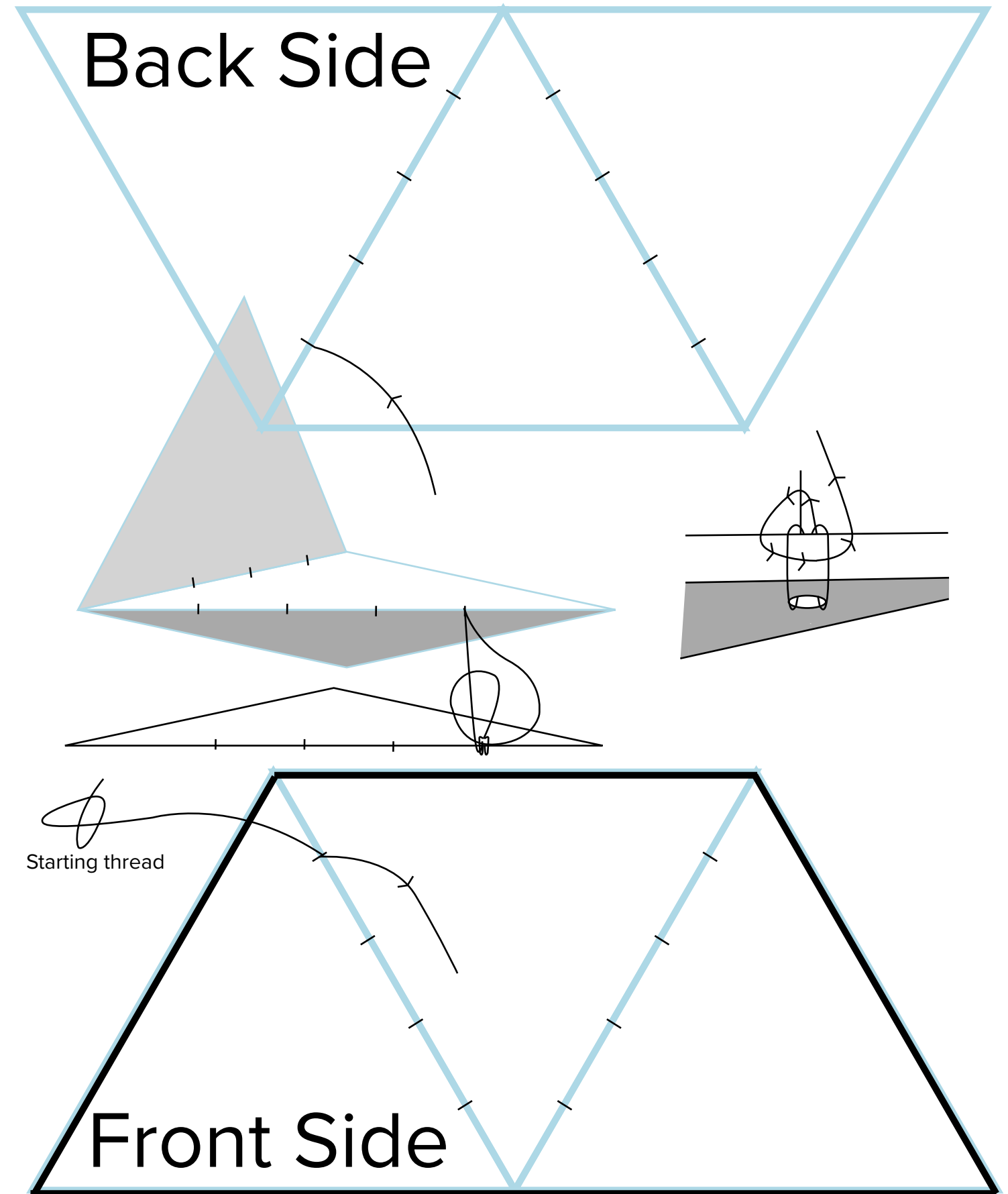

# Step 4

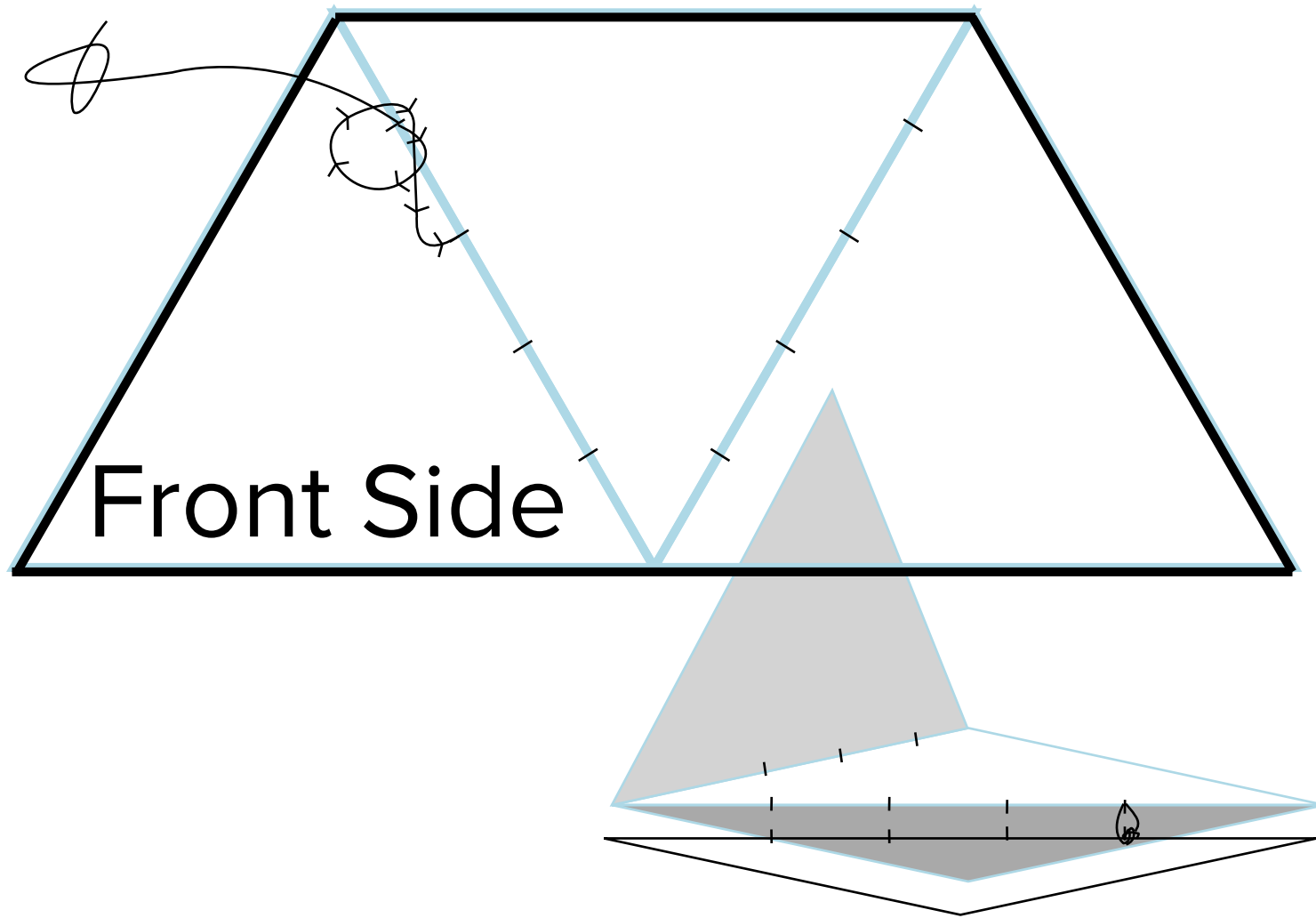

Step 4: Tighten the first folio as close as you can to the cover. Tie a knot around the starting thread. Tighten knot and proceed through the next hole.

Step 5: Repeat steps 1 through 3 taking care to keep the thread on the left side to help make it easier on yourself. Every time you do a loop do it on the left side towards, the next holes.

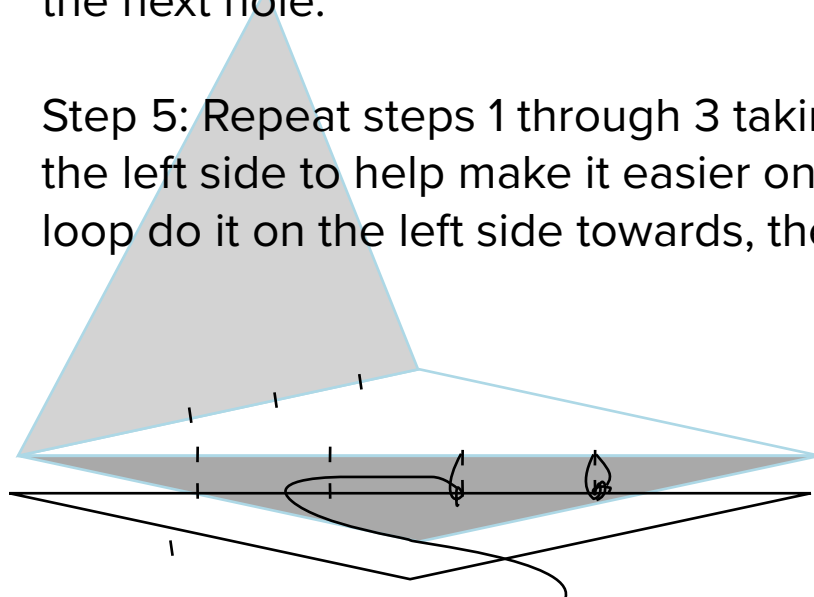

# Step 6

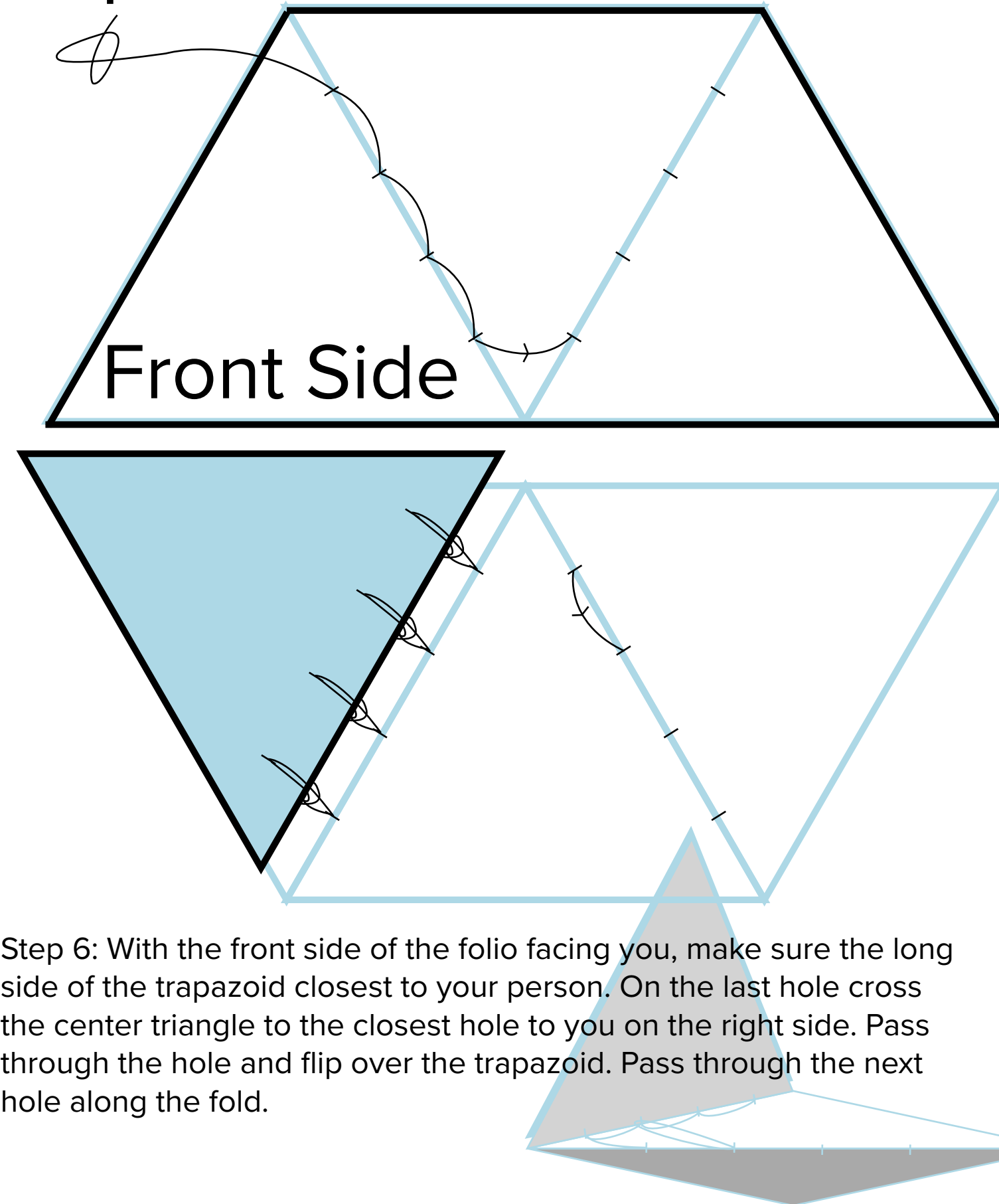

Step 6: With the front side of the folio facing you, make sure the long side of the trapezoid closest to your person. On the last hole cross the center triangle to the closest hole to you on the right side. Pass through the hole and flip over the trapezoid. Pass through the next hole along the fold.

# Step 7

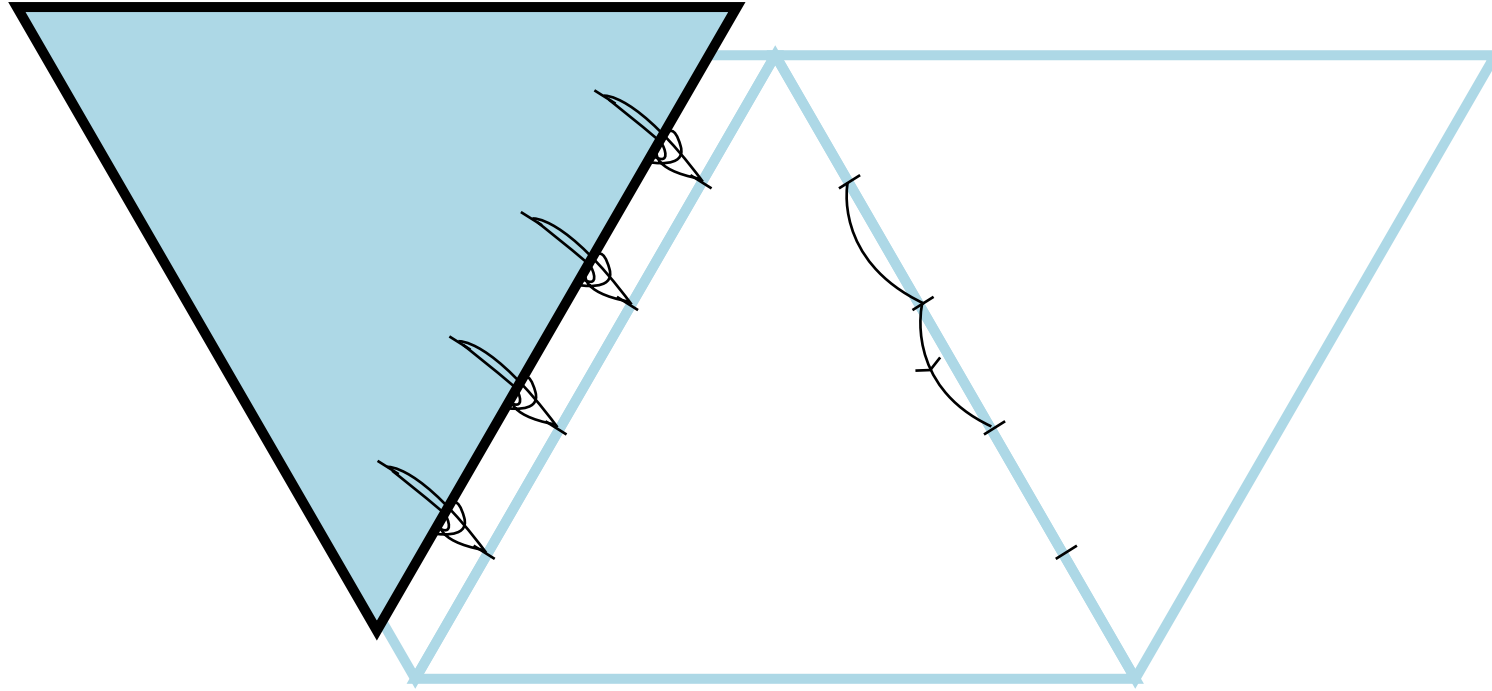

Step 7: Flip back over so the front side is facing you. Loop the thread underneath the part of string closest to you on the left fold. The section connecting the second to last and last hole. Continue the loop underneath the next segment of string connecting the second hold to the second to last hole. Return back through the hole you came through.

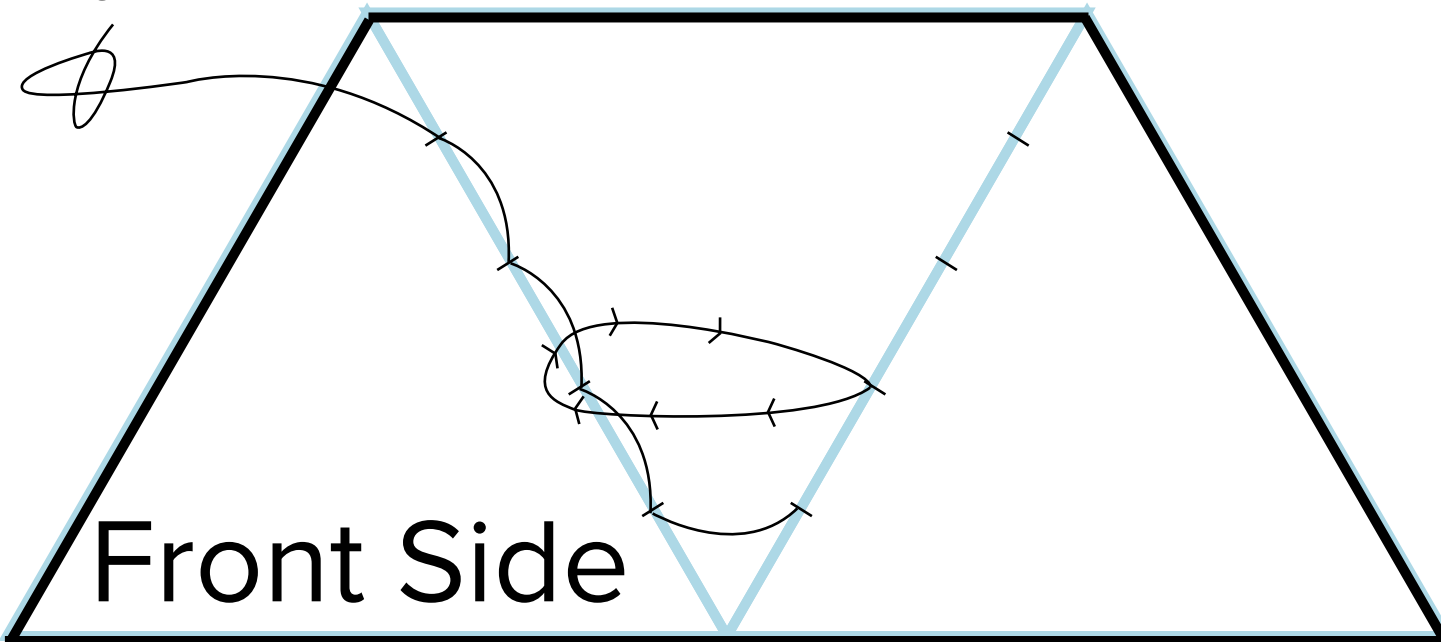

# Step 9

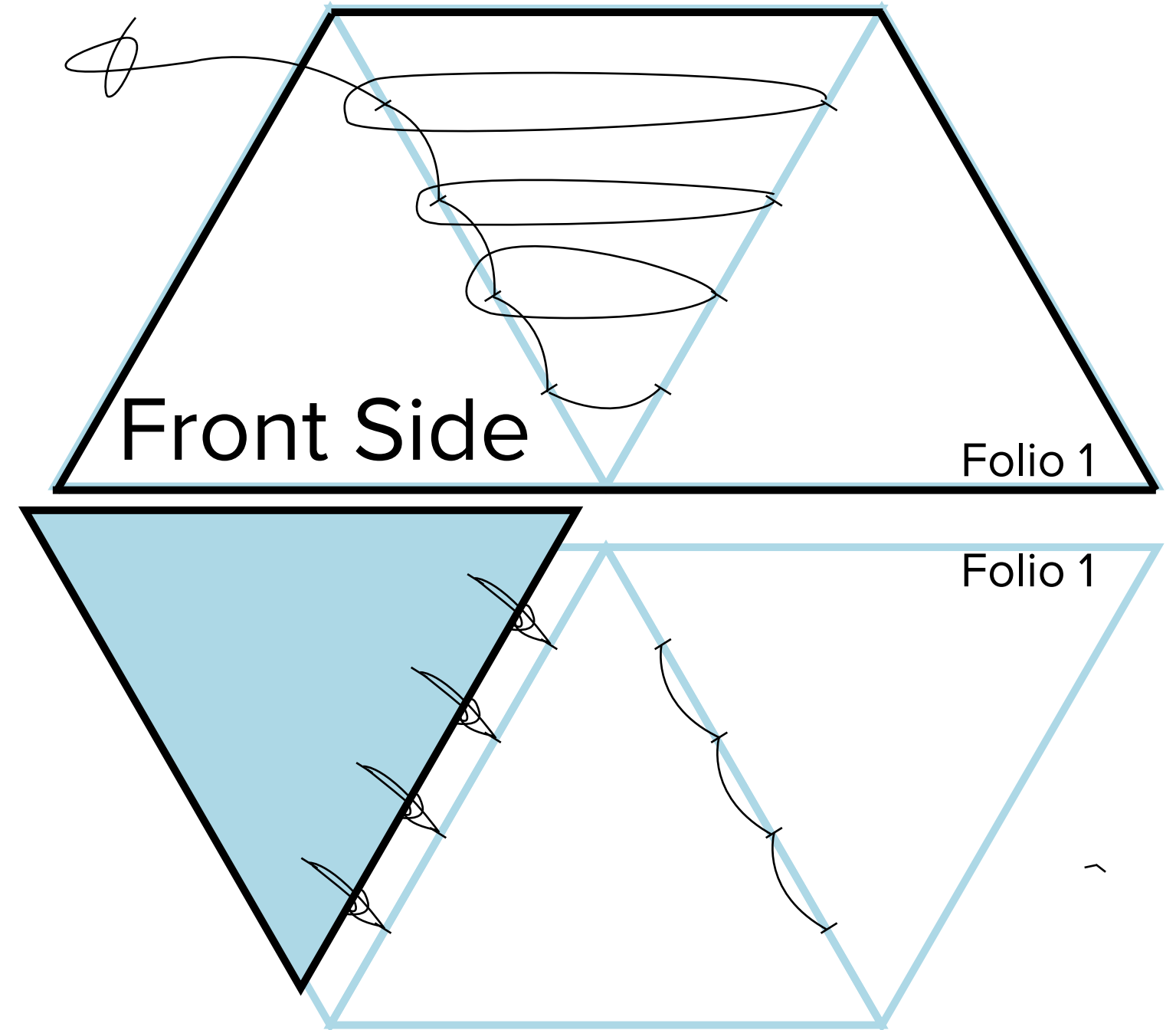

Step 8: Repeat steps 6 & 7 for the remaining holes on this fold.

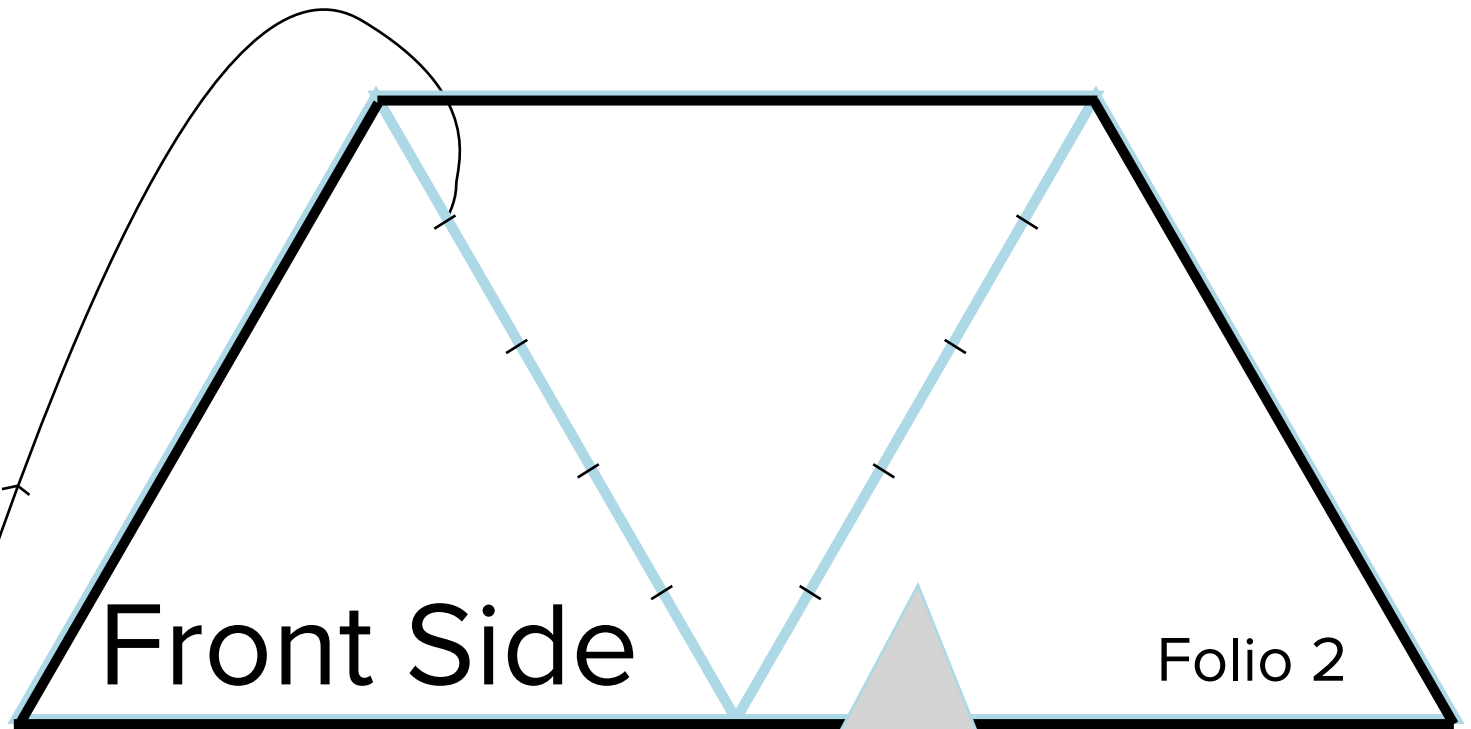

Step 9: Pass the thread through the last hole on the front side of the first folio so the thread lines up with the fold. Follow the thread along the bottom fold on the right side of the back of the first folio. Once you reach the end, follow the fold on the left most fold on the front of folio 2 so it lines up and enters the upper left most hole on the second folio front side.

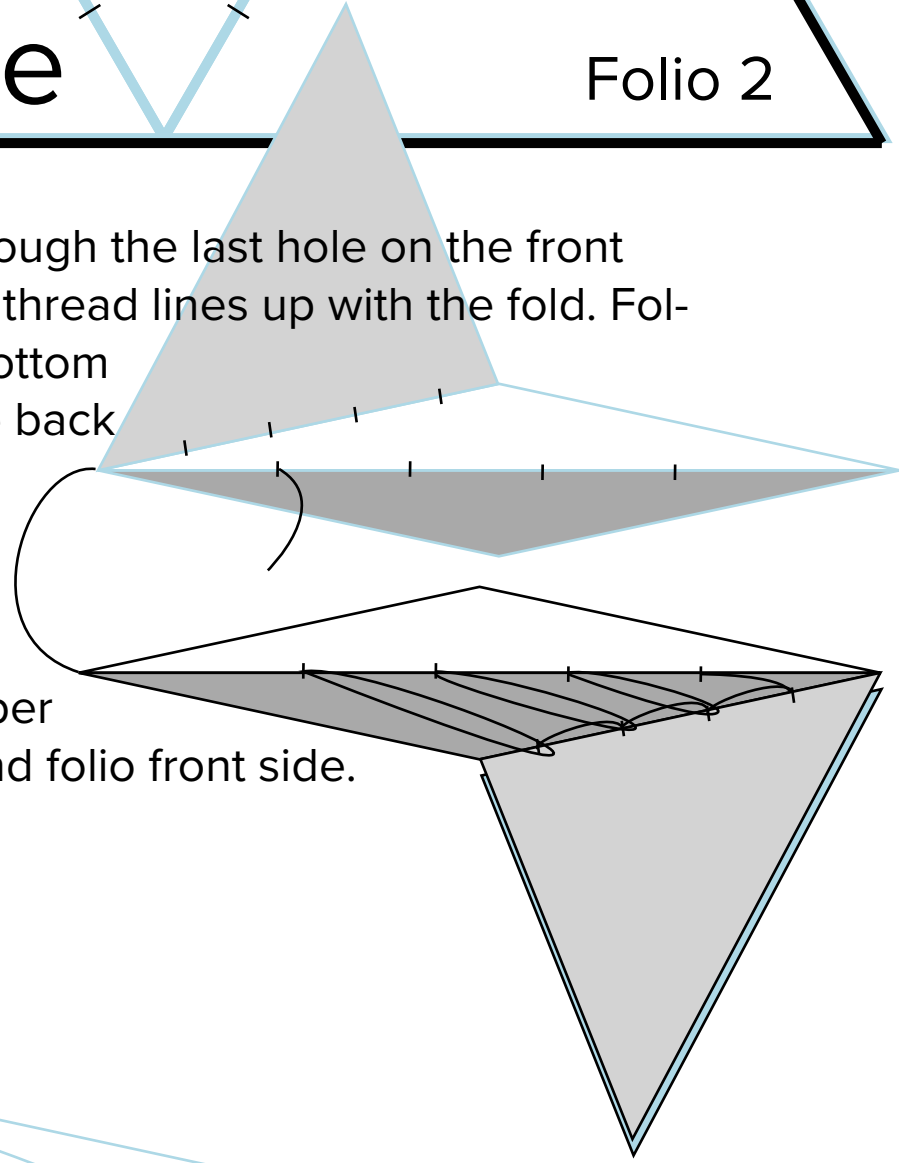

# Step 10

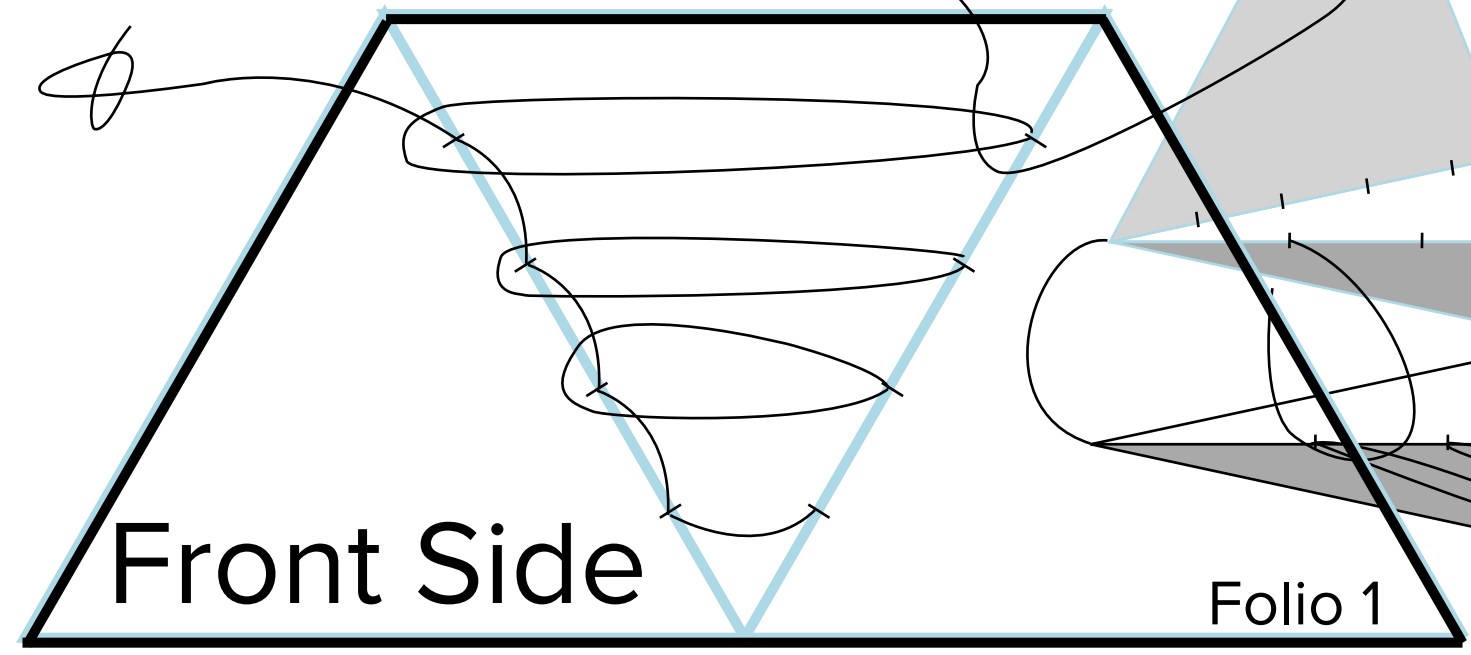
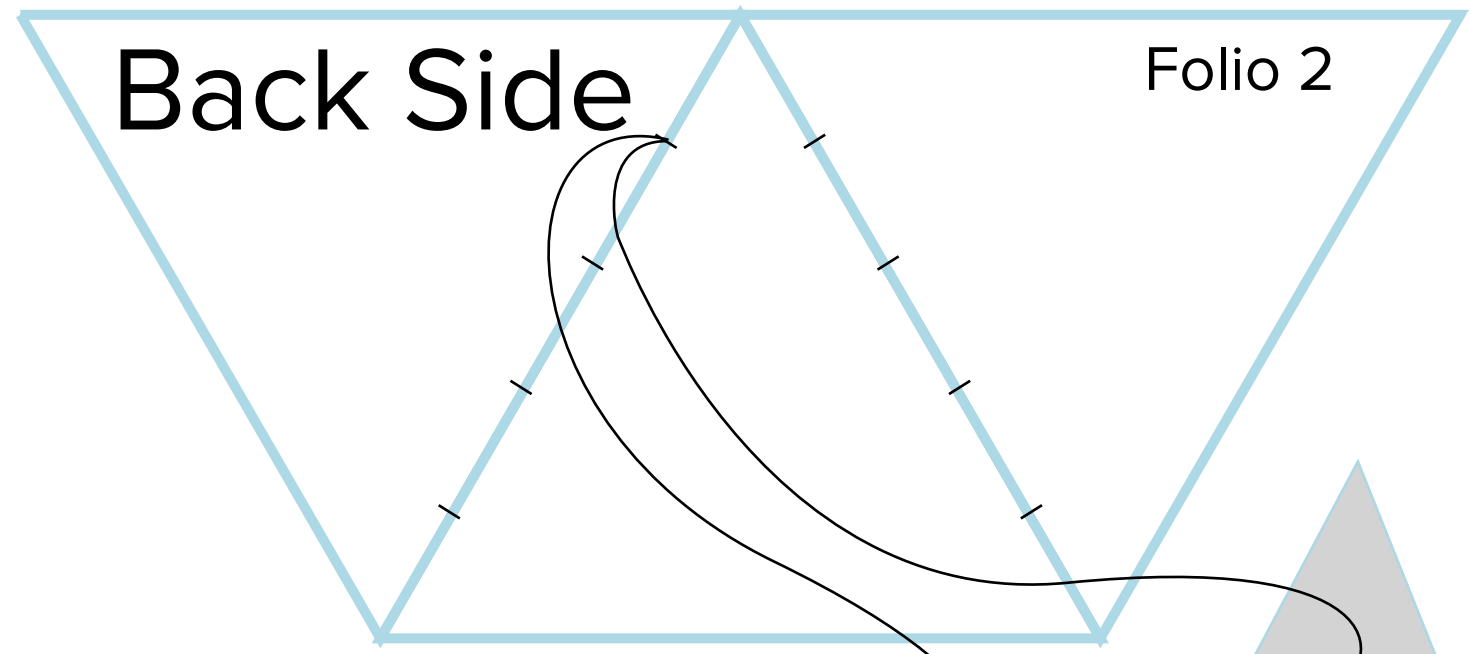

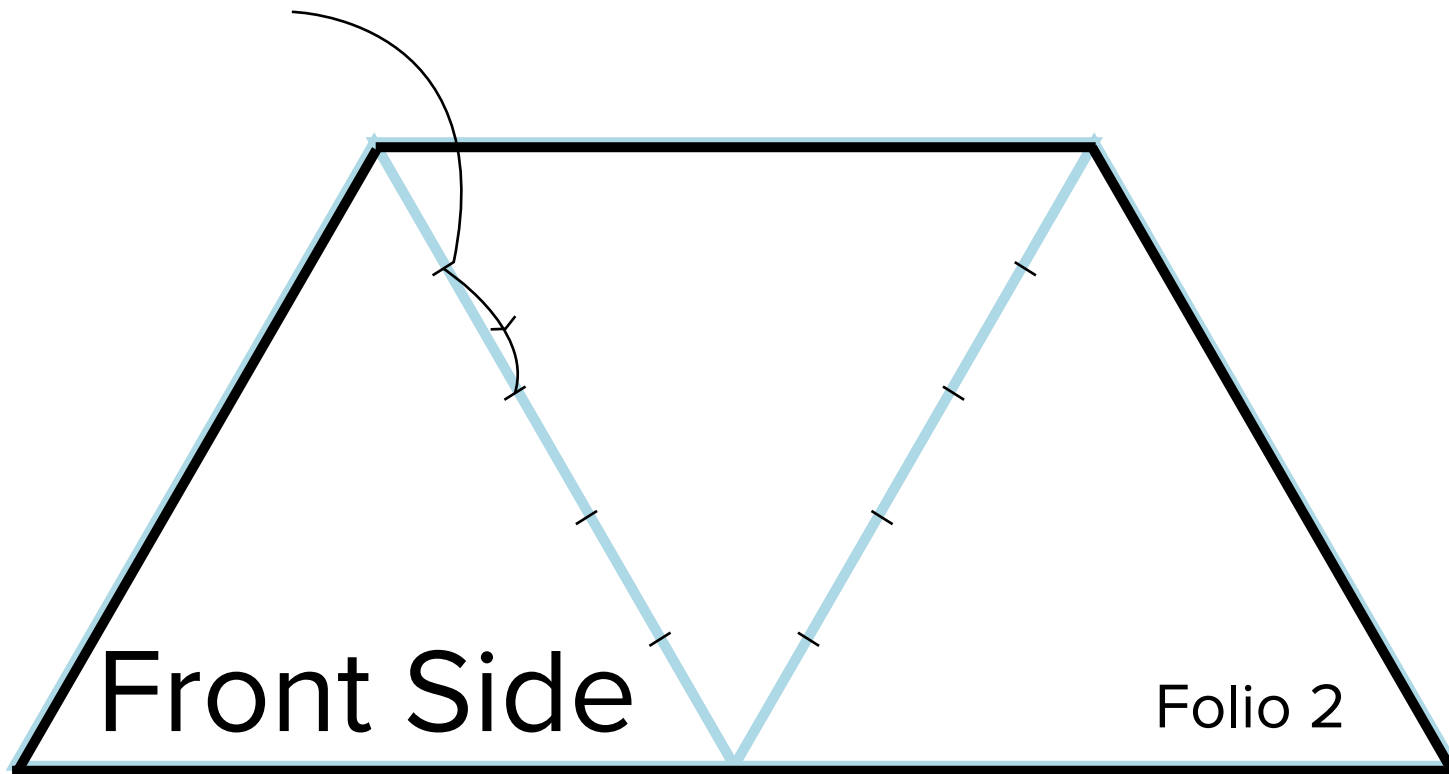

Step 10: Enter the first hole on the second folio, exit through the back side of the second folio. Line up the first and second folio so that the right most triangle of the front side of folio one lines up with the left most triangle of the back of folio 2. Take the thread and pass it underneath the loops made across the center triangle in the front side of folio one. Pass from the right side to the left side so that the thread crosses itself when returning back into the folio. Tighten and return through hole.

Step 11: Repeat step 10 for the rest of the fold.

Step 12: Repeat steps 6-10 until you get to the back cover

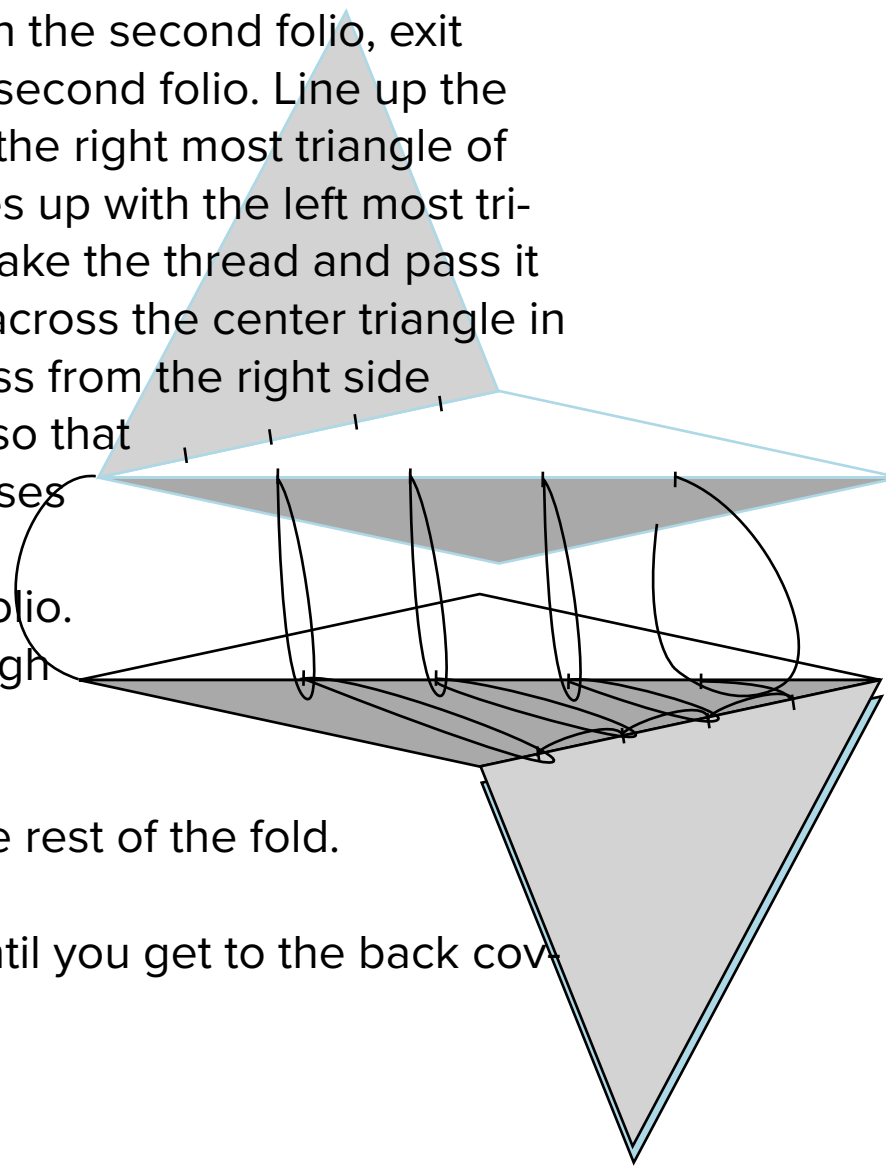

Step 13: Once you get to the final fold on the final folio exit through the top hole on the back of the final folio. (see diagram) You should have it positioned so the smaller side of the trapezoid shape of the folio faces you. Line up the back cover so that it lines up with the last page of the journal, make sure the outside of the cover is facing you. Enter through the top most hole of the back cover. Create a loop by going back through the same hole on the cover. Take your thread and wrap it around the original piece of thread coming out of the first hole on the fold of the folio. Wrap it clock wise around the original thread and then enter back into the hole in the folio.

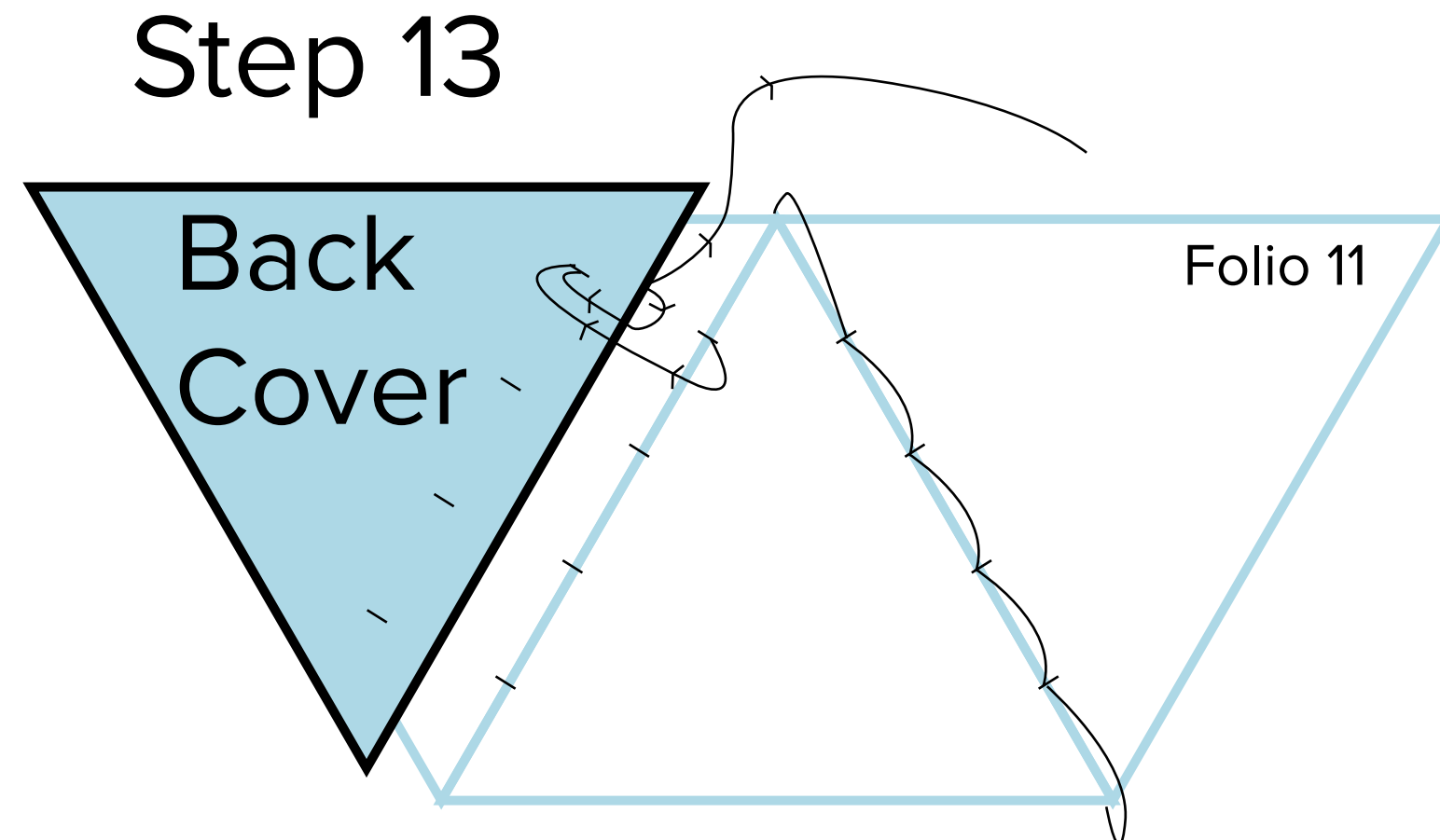



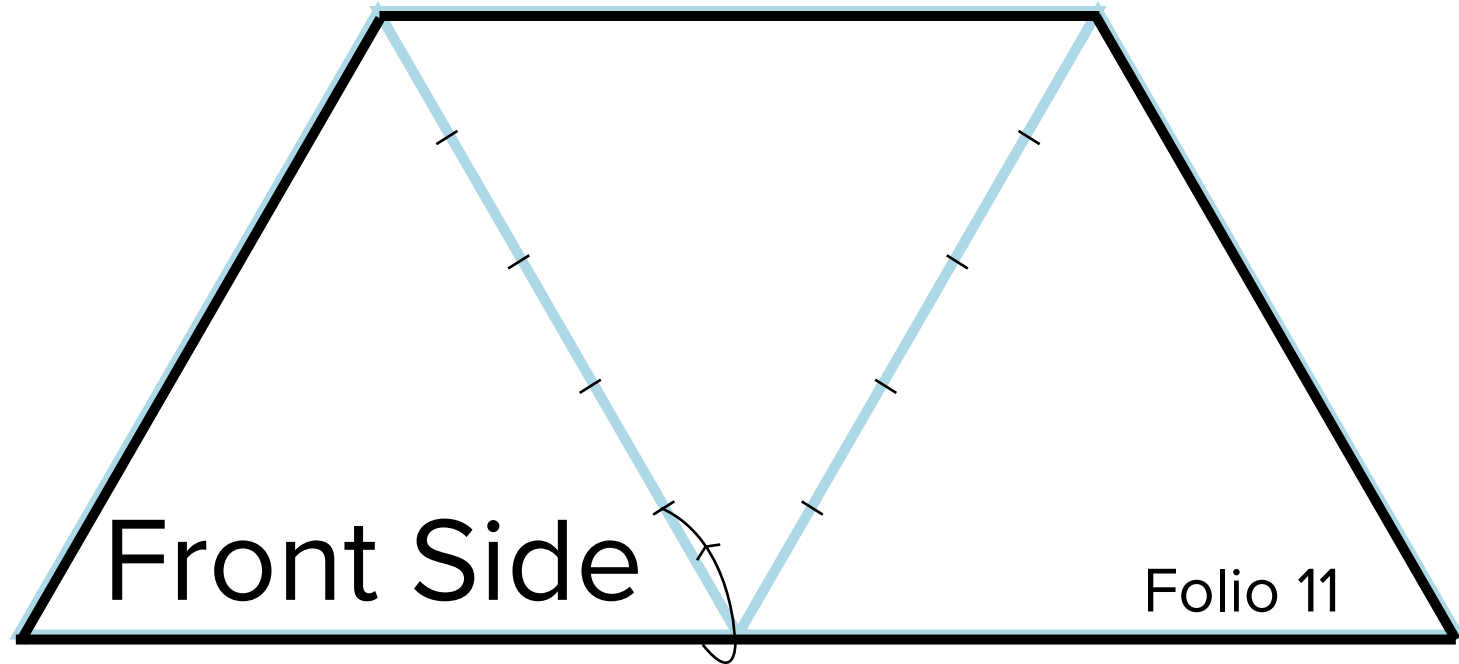

# Step 14

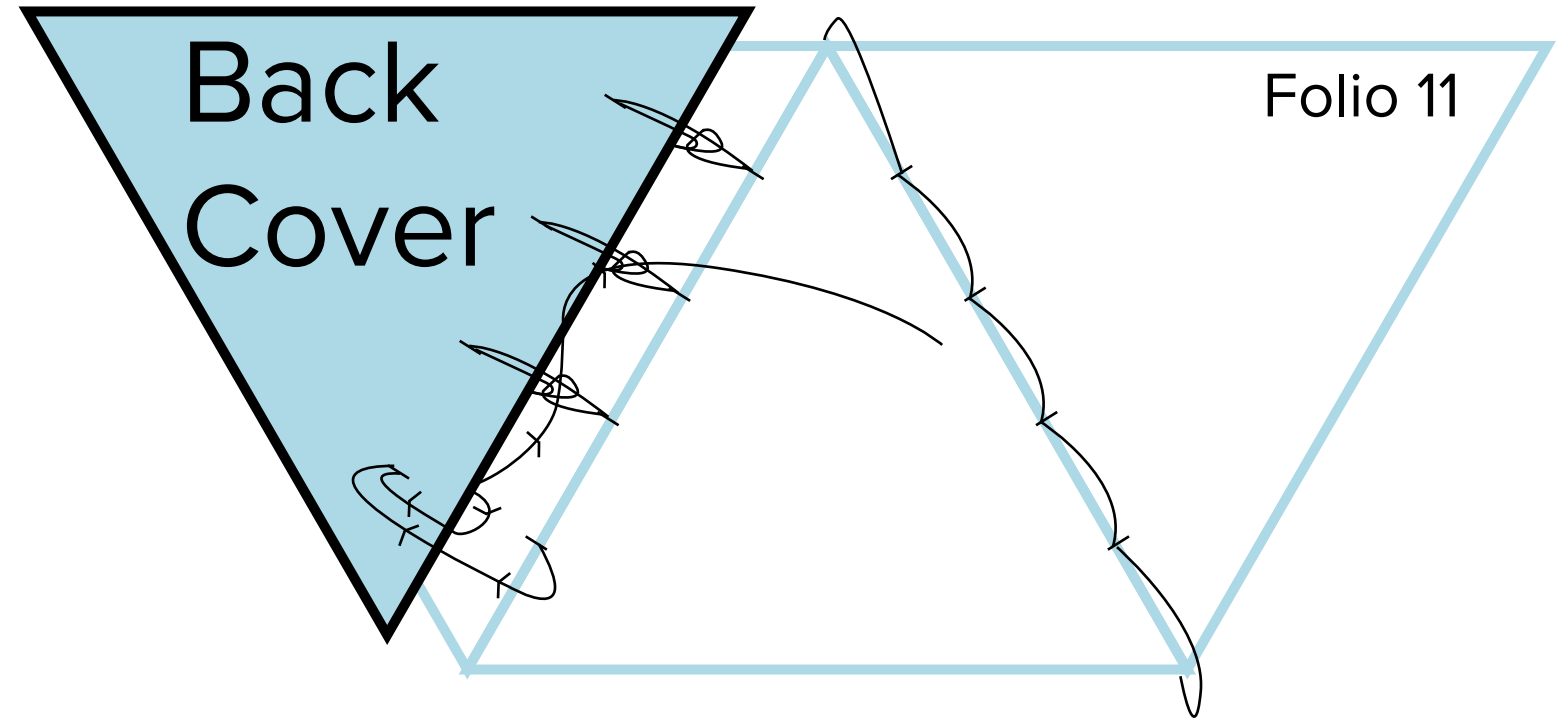

Step 14: On the inside of the last folio continue down the fold repeating step 13 with the remaining holes.

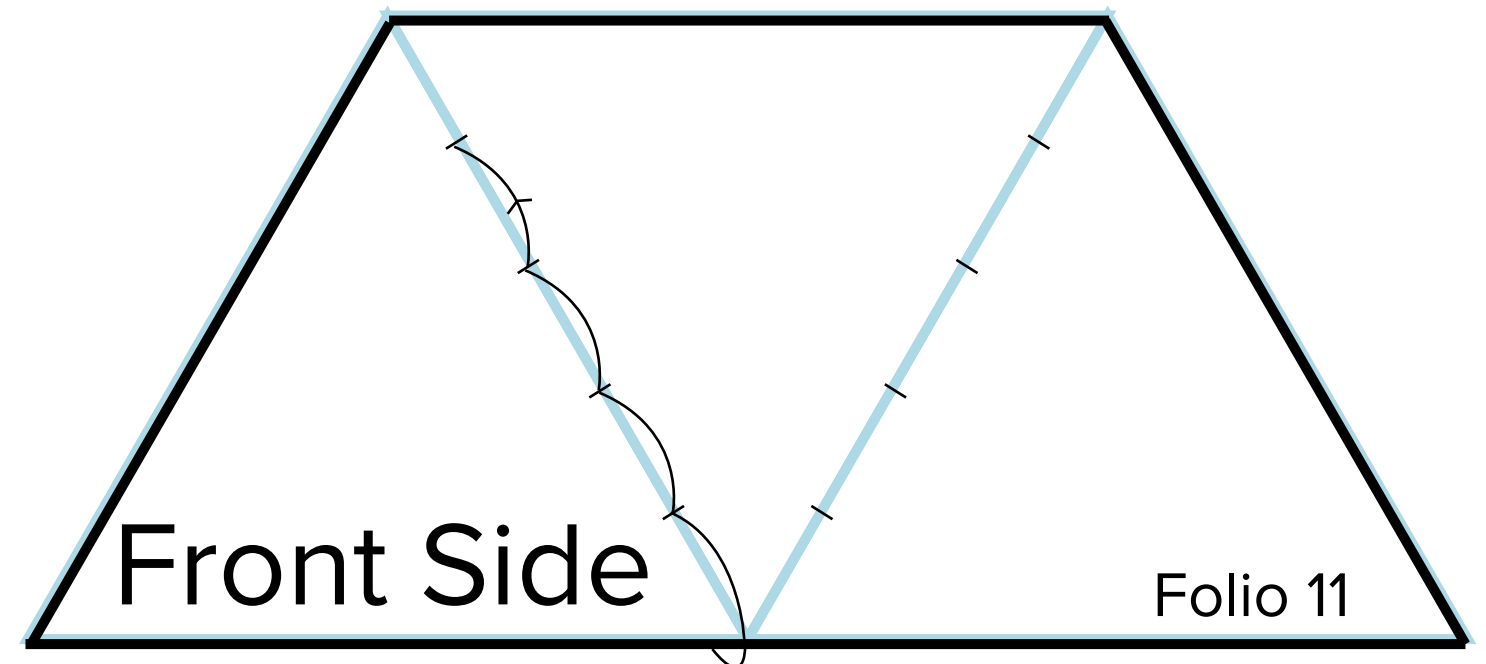
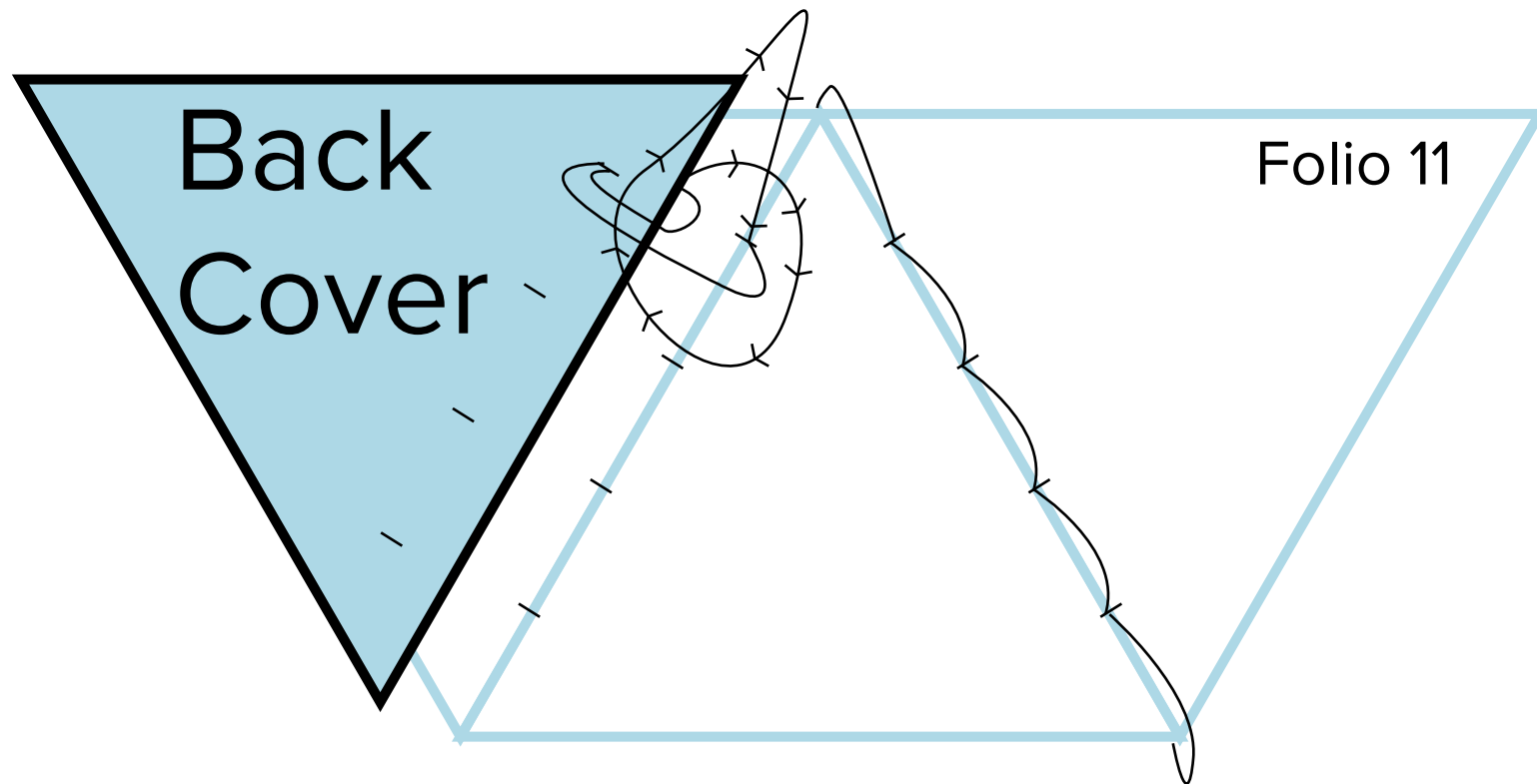

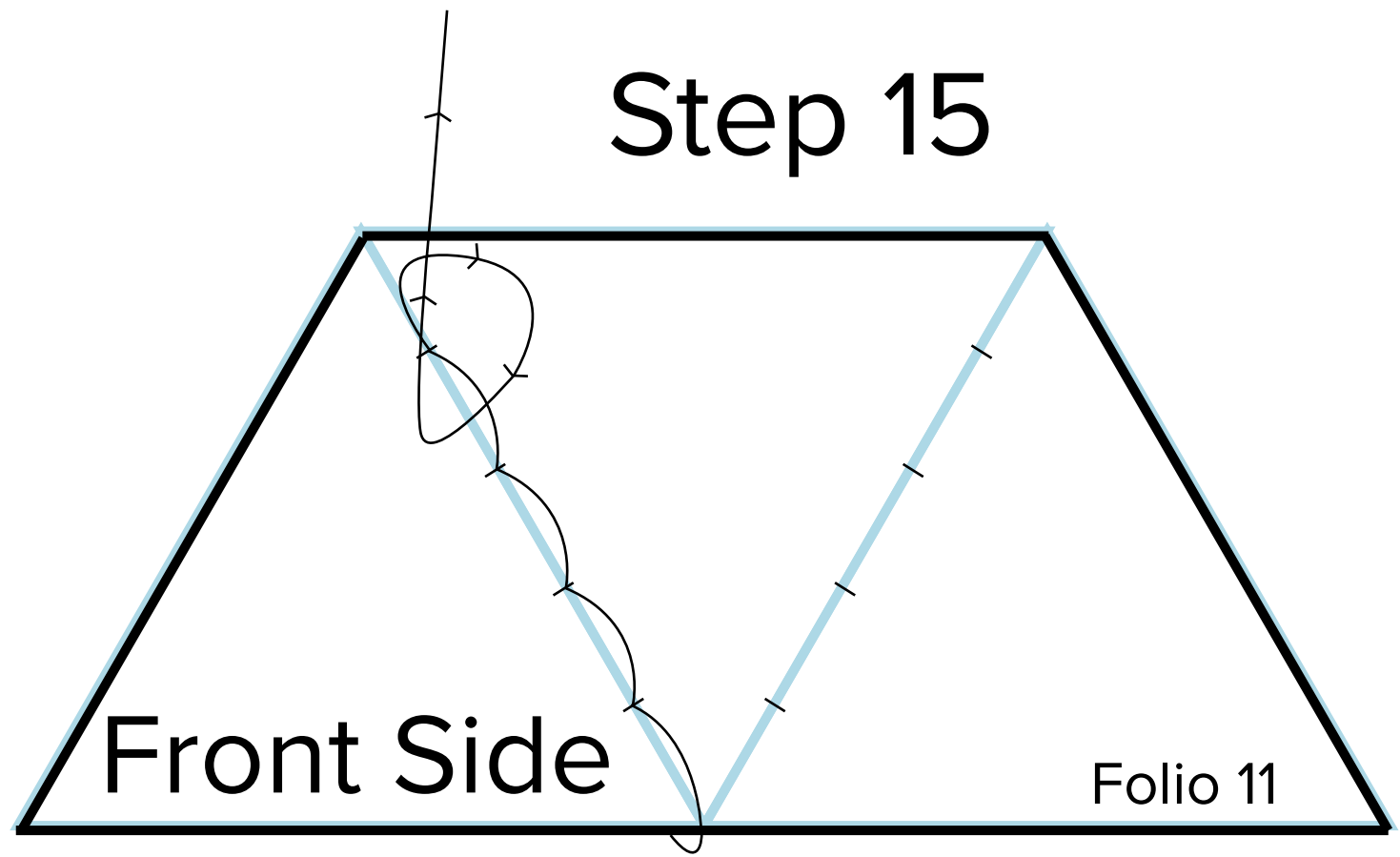
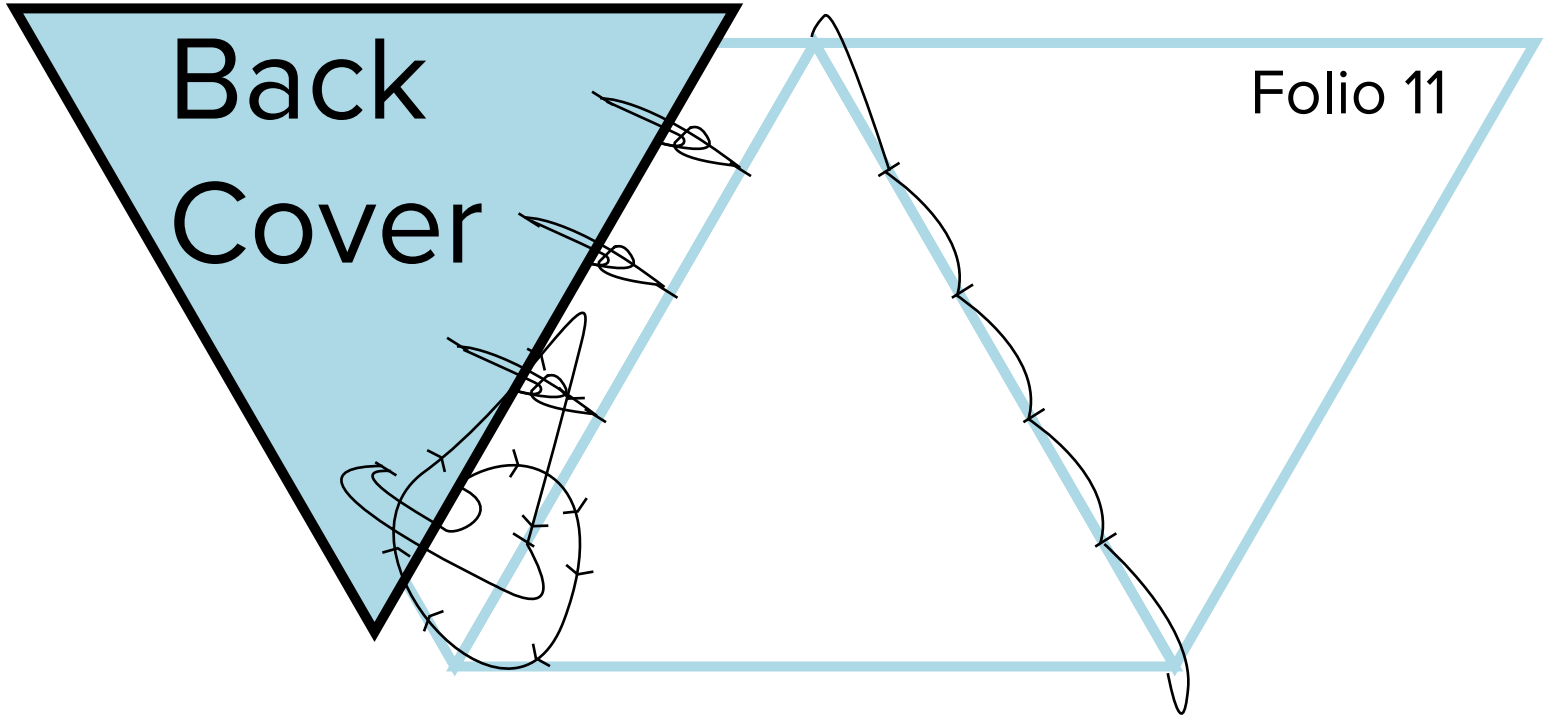

Step 15: Once you have repeat step 13 on the last hole, take the remaining thread and tie a knot underneath the thread to secure the book.